

INDIA'S MOST TRUSTWORTHY AUTO INSPECTION & VERIFICATION SERVICE

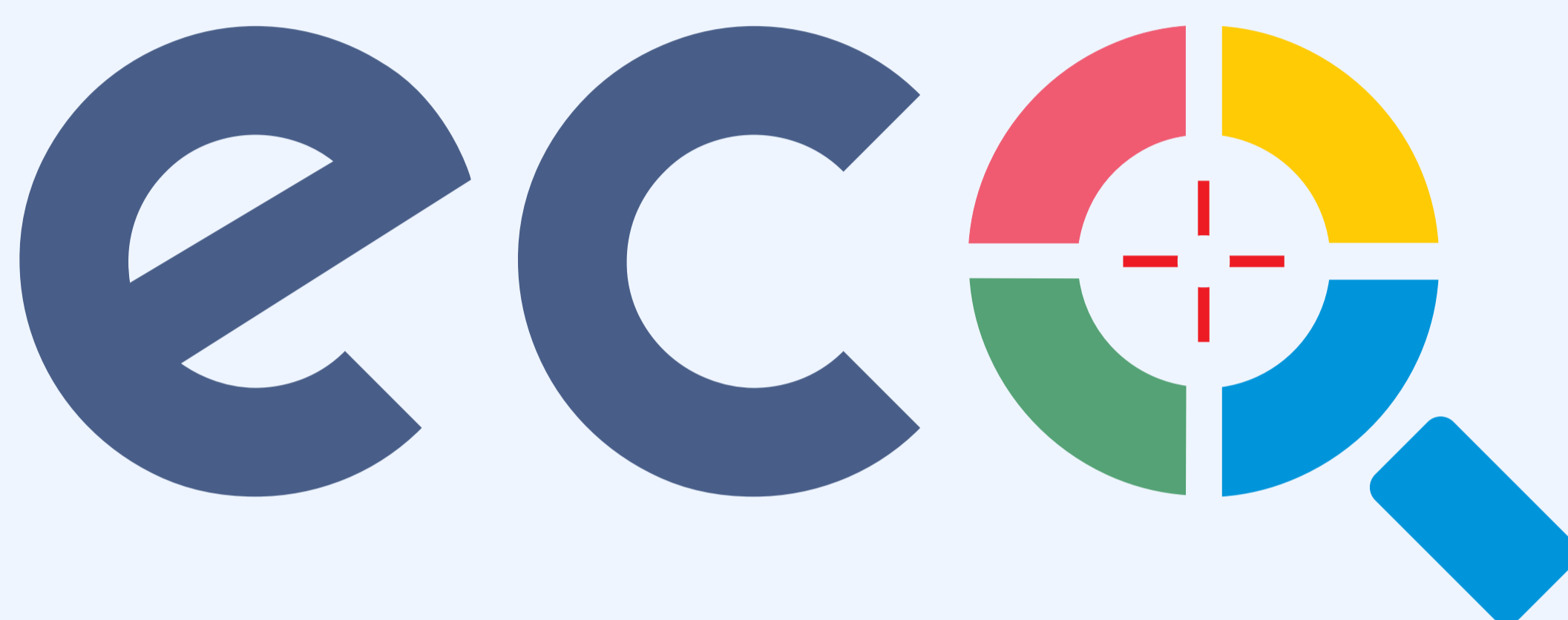

AI & Tech Driven Inspection & Certification



Independent



Unbiased



Objective



Comprehensive

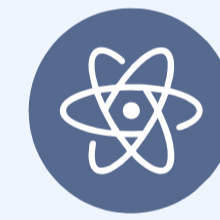

Scientific

- a service by **droom**

ECO INSPECTION REPORT

India's Most Comprehensive And Scientific Vehicle Inspection Service

Ordered By



Anant Goel

10 / 01 / 2021

Gurgaon

Inspected By

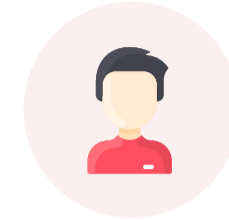

Mitesh Karwa

Verified Technician

36+ Vehicle Inspected

4+ Years Experience

Audi A4 Premium Plus, 2019

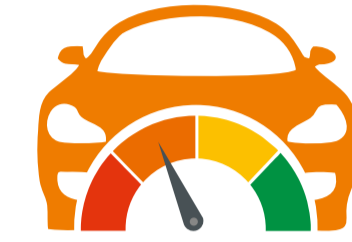
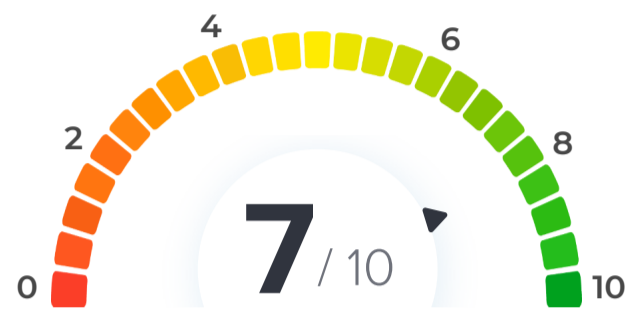

₹ 1,18,233



Automobile from individual in good condition is valued

Vehicle Information

Make	Audi	Transmission Type	Automatic
Model	A4	Registration Type	Private
Year	2019	Registration No.	DL10CG3657
Trim	Premium Plus	VIN/Chassis Number	16191
Exterior Color	Terra Gray	Kms Run	25105
Interior Color	Beige	Manufacturing Date	2022-05-20
Body Type	Sedan	Registration Date	2022-07-15
Fuel Type	Petrol	Insurance Expiry	2020-7-14
Engine CC	200	CNG Validity	2025-6-20
Engine No.	452390	Location	Janak Puri
Number of Owners	2	Engine Sound Link	Listen Engine Sound

Key Highlights

Flood Damage	No	Insurance Copy Available	No
Tyre Life Remaining (KM)	25,105	Service Logs Available	No
Dent	Yes	Bank Hypothecation	No
Major Accidents	No	Bank NOC	No
RC Copy Available	Yes (Original)		

ECO Repair Estimate

Total Repair Estimate ₹ 10250

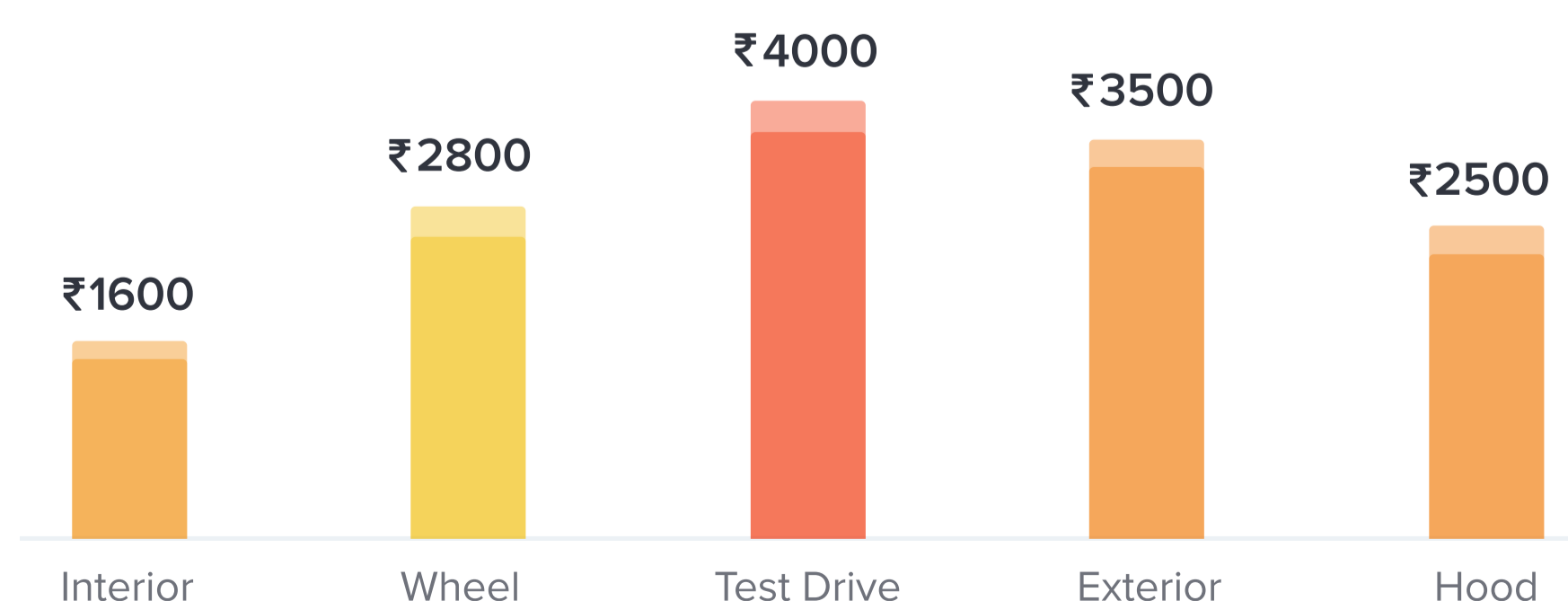

ECO OVERALL SCORE BREAKDOWN

Interior

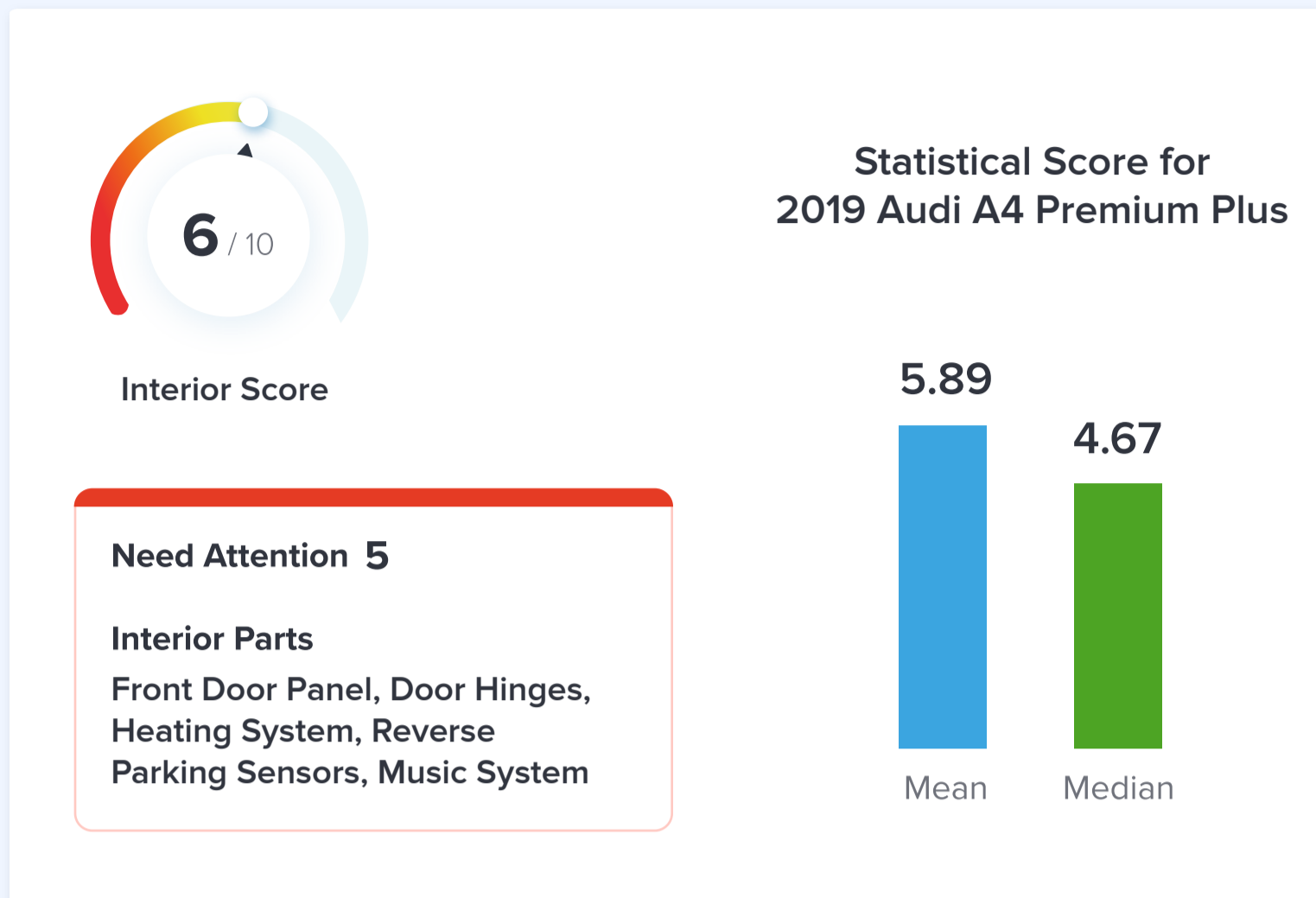

Exterior

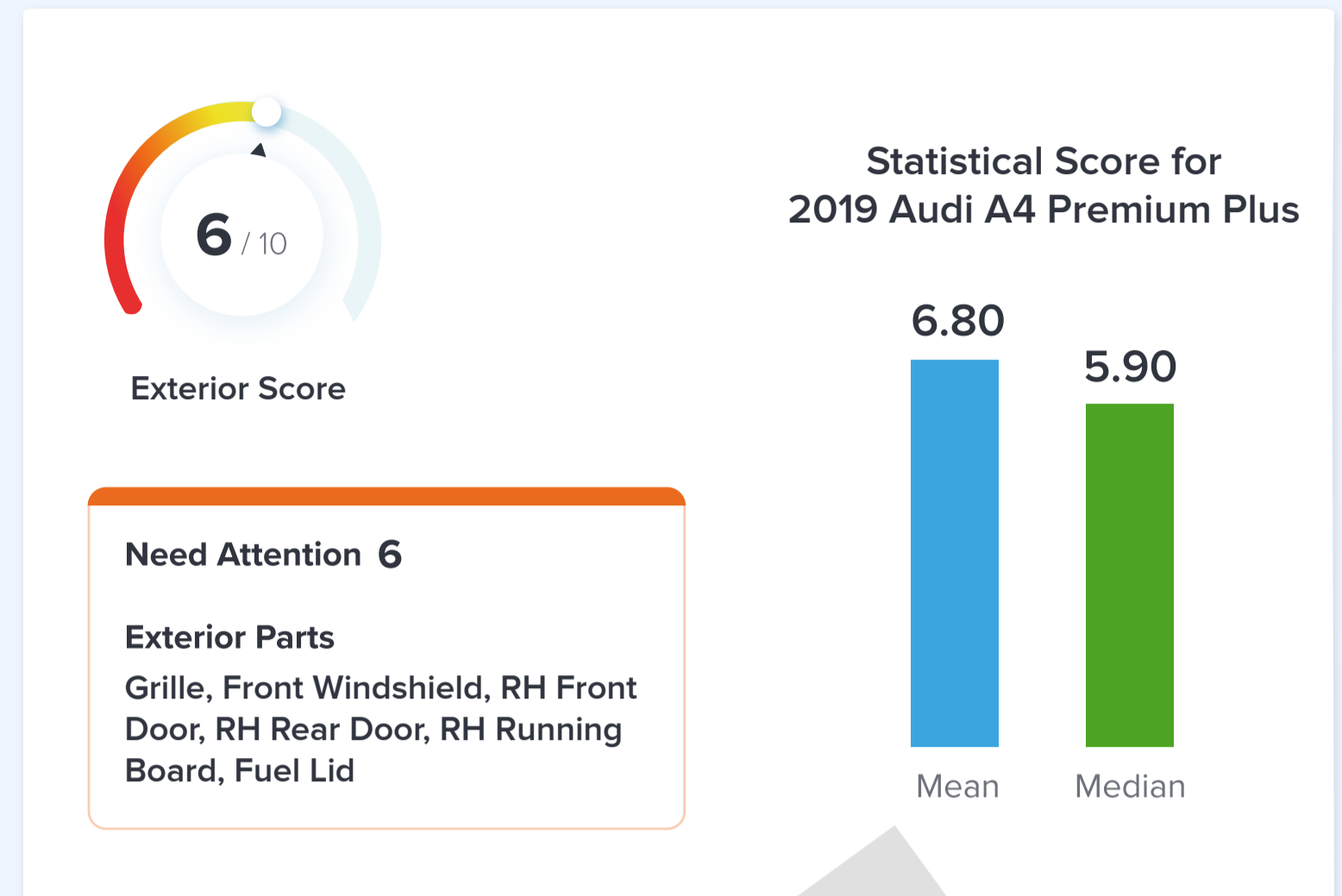

Wheel

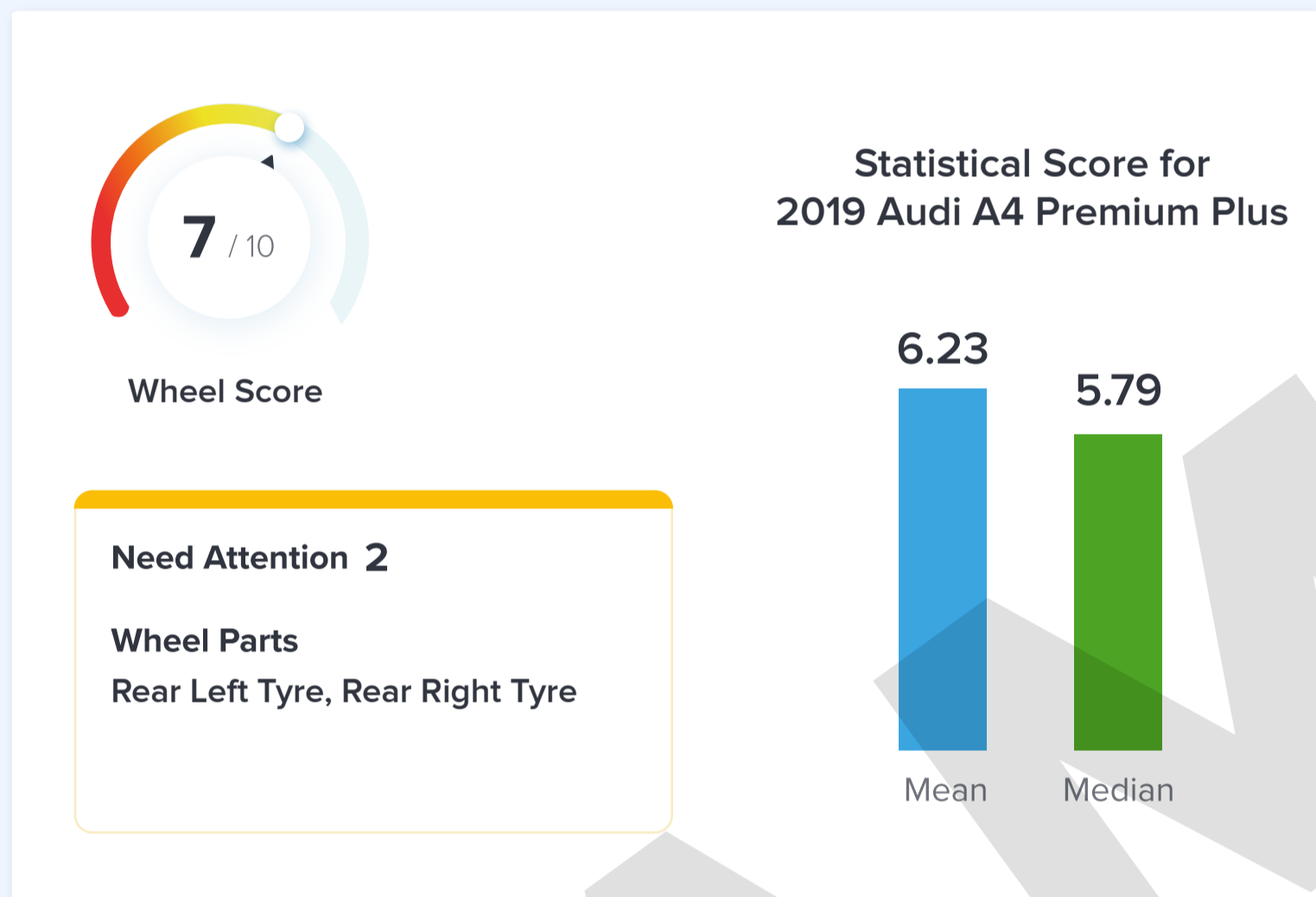

Hood

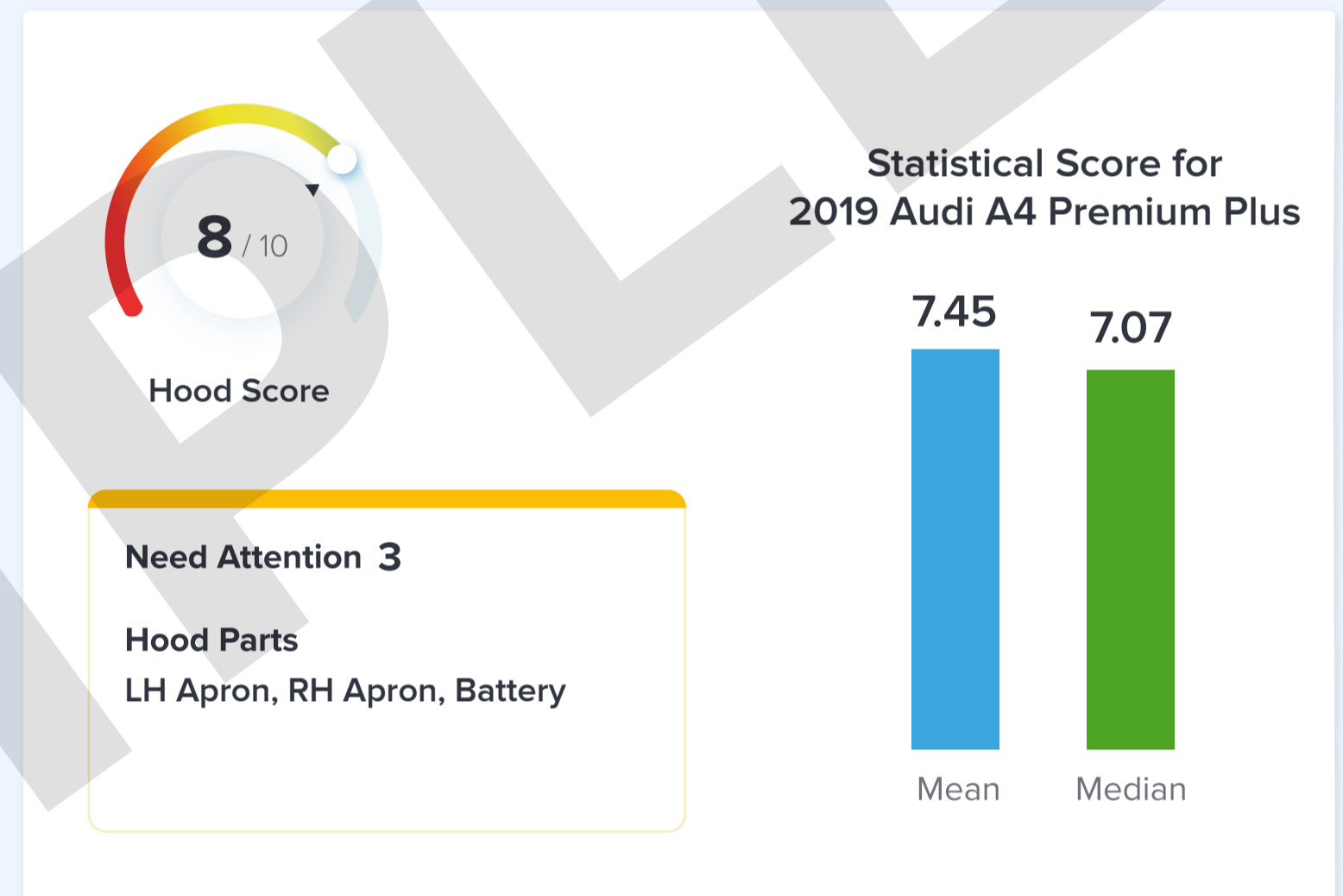

Test Drive

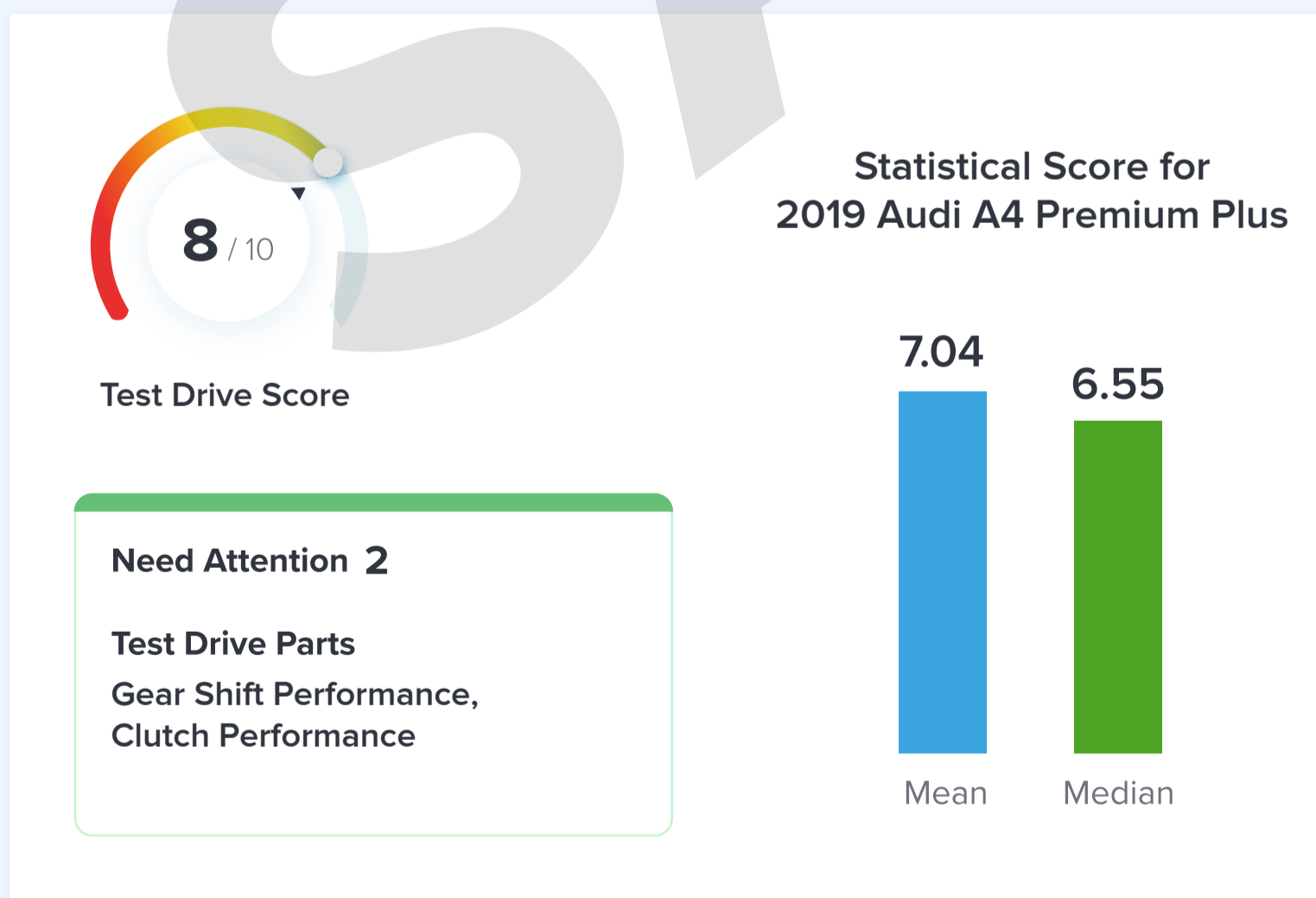

EXTERIOR

Vehicle Exterior View and Condition

0 Critical
 2 Bad
 4 Below Average
 6 Average
 8 Good
 10 Excellent

Grille	6		
Front Bumper	8		10 Paint Condition
Front Windshield	8		4 Hood
Left Fender	4		10 Antenna
LH Side View Mirror	10		10 RH Fender
Roof	10		6 RH Side View Mirror
LH Front Door	10		10 Pillars
LH Running Board	6		8 RH Front Door
LH Rear Door	10		6 RH Running Board
Fuel Lid	2		4 RH Rear Door
LH Quarter Panel	6		8 RH Quarter Panel
Trunk Lid / Tail Gate	10		8 Body Rust
			8 Rear Windshield
			10 Rear Bumper

Front License Plate is available?	✓
License Plates are HSRP complaint?	✗
Head Lights are working?	✓
Turn Signal lamps are working?	✗
Hazard Lamps are working?	✓
License plate light is working?	✓
Rear windshield wiper is working in good condition?	✓

Rear License Plate is available?	✓
HSRP colour sticker is available?	✗
Tail Lights are working?	✓
Fog Lamps are working?	N/A
Break lights are working?	✓
Front windshield wiper is working in good condition?	✓
Reverse parking lights are working?	✓



Exterior Images

FRONT VIEW



REAR VIEW



LEFT SIDE VIEW



RIGHT SIDE VIEW



LEFT FRONT CORNER VIEW



LEFT REAR CORNER VIEW



RIGHT FRONT CORNER VIEW



RIGHT REAR CORNER VIEW



INTERIOR

Vehicle Interior View and Condition



Music System is working properly?	✓
Navigation System is working properly?	✗
Horn is loud & clear?	✓
Sun Visors are working properly?	✗
Luggage Compartment light is working properly?	N/A
Power Windows are working?	✓
Carpets are in good condition?	✓
Front Seat Belts are working properly?	N/A
Boot Lever is working properly?	✗
Front De-Fogger is available?	✓
USB port is available?	✓
Rear view mirror is functional?	✓
Passenger side seat adjustments are working properly?	✓
Odometer/Trip switches are working properly?	✓

Speakers are working properly?	✓
Steering Mounted Controls are working properly?	N/A
Handbrake is working properly?	✓
All Cabin lights are working properly?	N/A
Central Lock is working?	✓
Floor Mats are available?	✓
Seat Covers are in good condition?	✓
Rear Seat Belts are working properly?	N/A
Fuel Lid Lever is working properly?	✓
Bonnet Lever is working properly?	✗
Rear De-Fogger is available?	✓
Glove box light is working?	✓
Driver side seat adjustments are working properly?	✓



Interior Images

DASHBOARD VIEW



CLUSTER METER VIEW



FRONT SEATS



REAR SEATS



GLOVE BOX



INTERIOR REAR VIEW



INTERIOR FRONT VIEW



INTERIOR DOOR PANEL



WHEELS

Wheel View and Condition

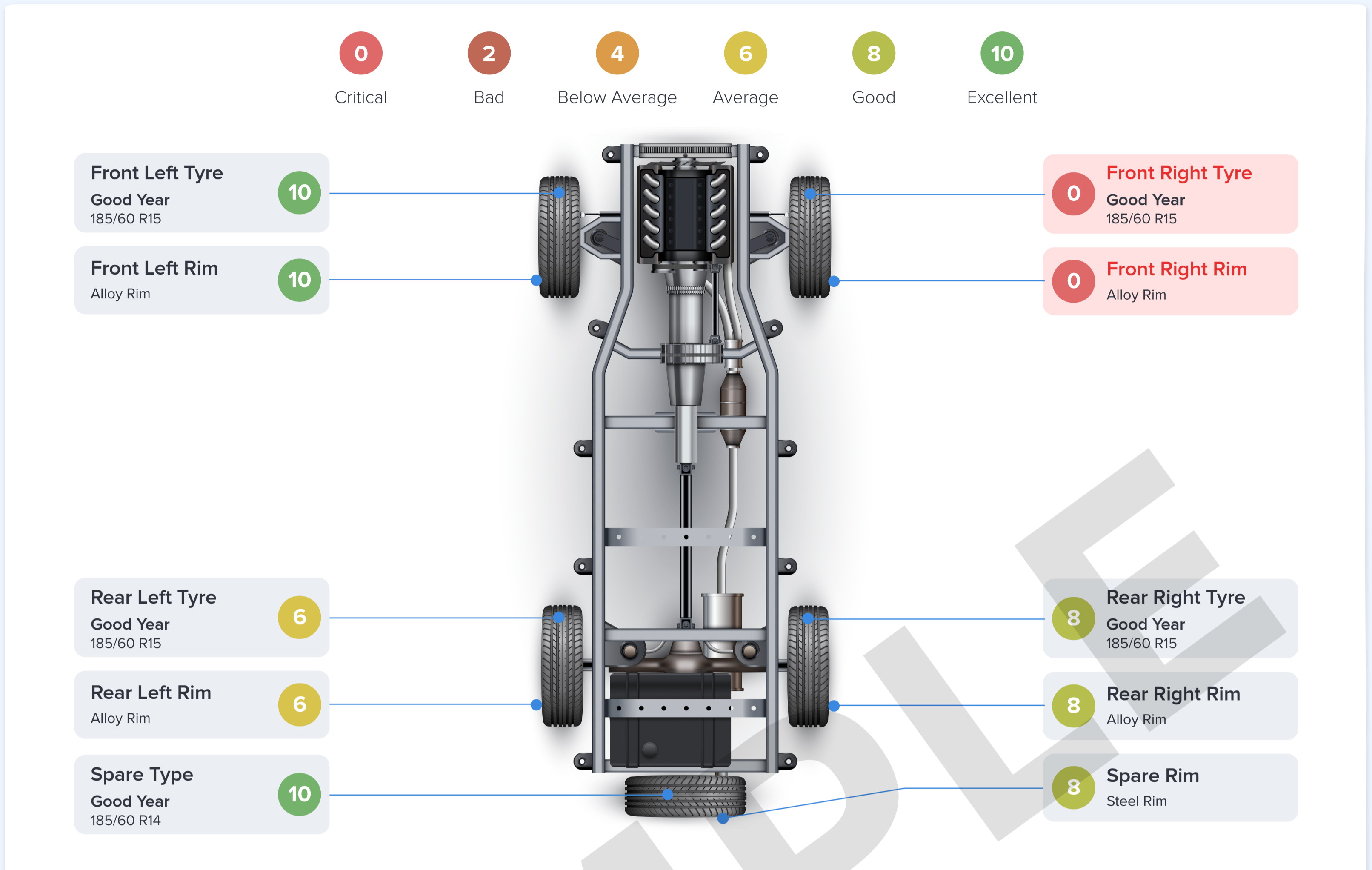

Wheels Images

RIGHT FRONT TYRE



RIGHT REAR TYRE



LEFT FRONT TYRE



LEFT REAR TYRE



TEST DRIVE

Test Drive and Condition

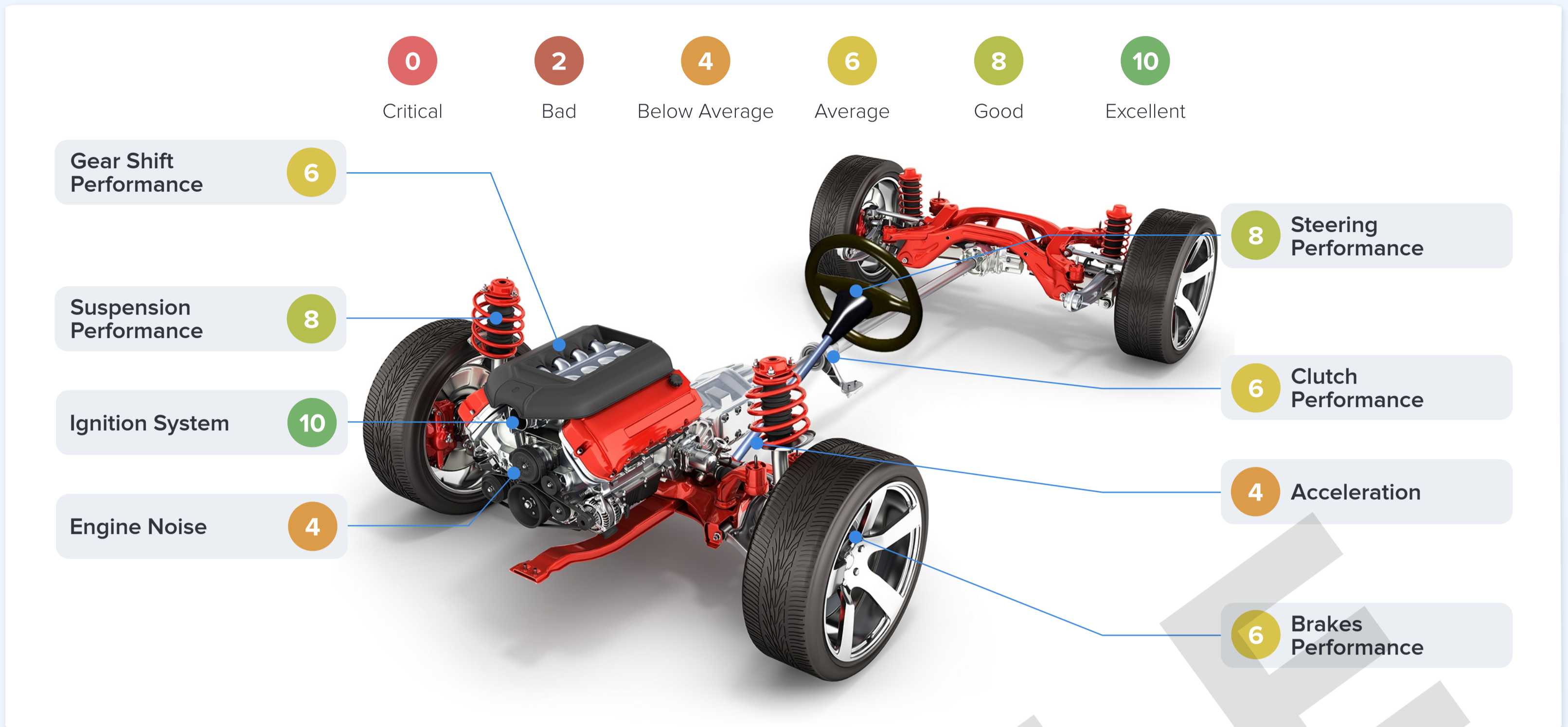

HOOD

Vehicle Hood View and Condition

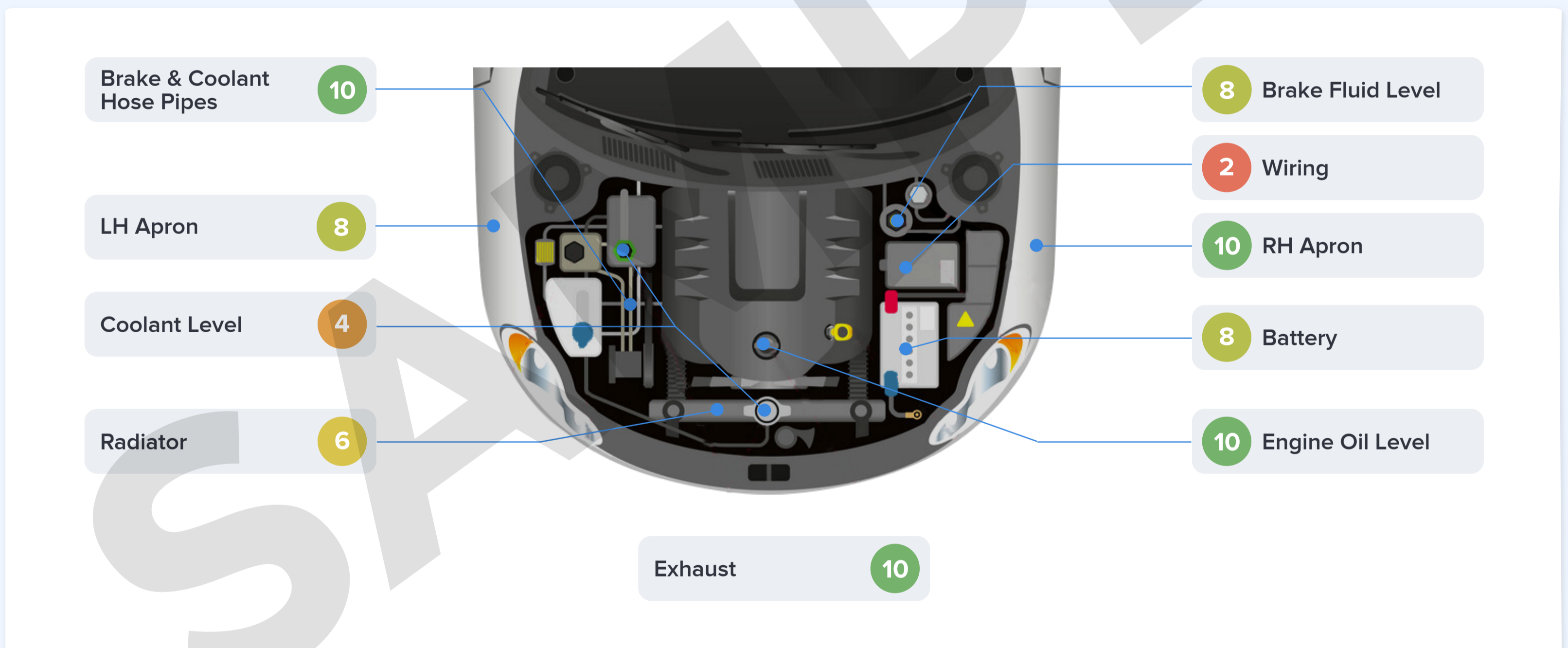

Hood Images

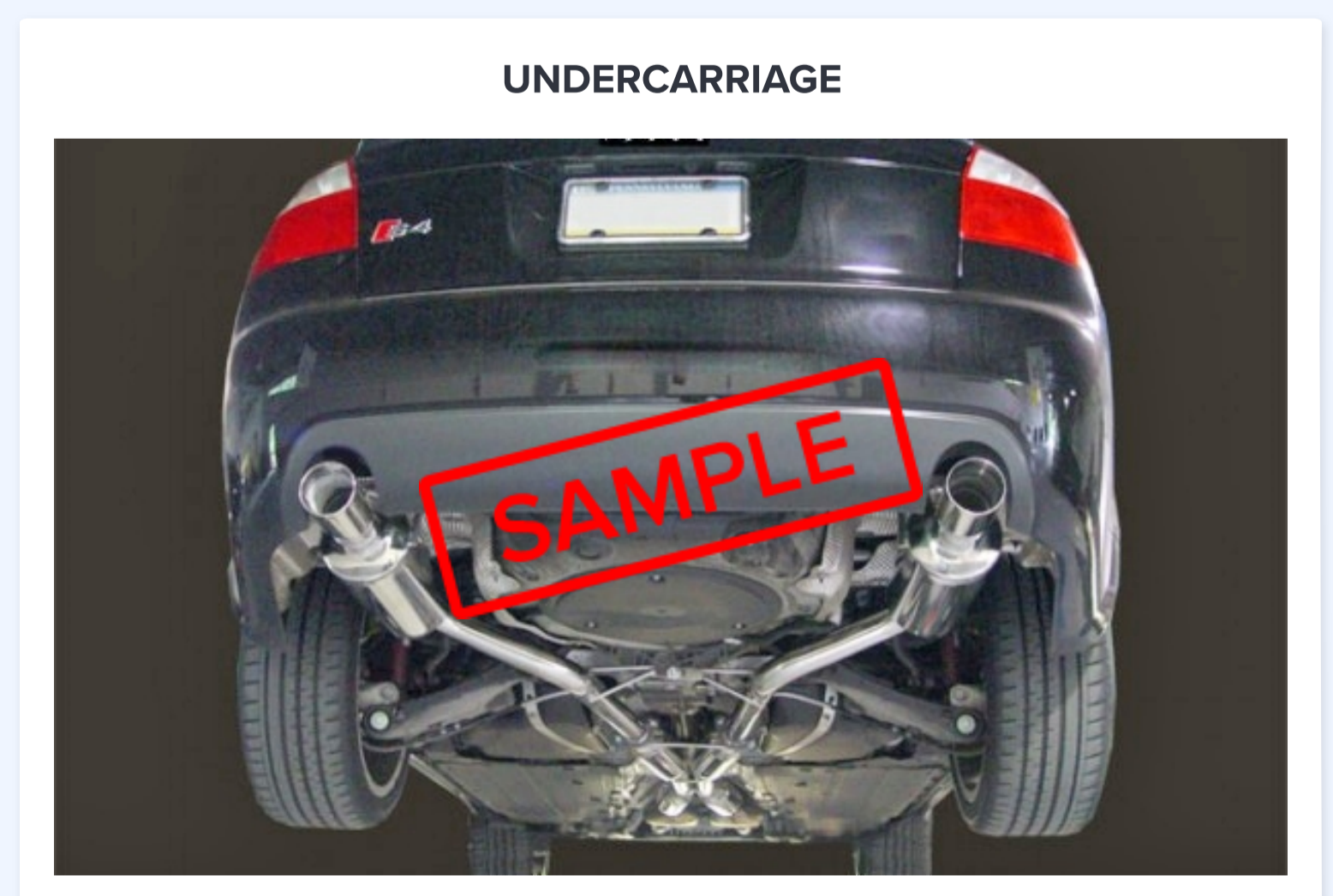
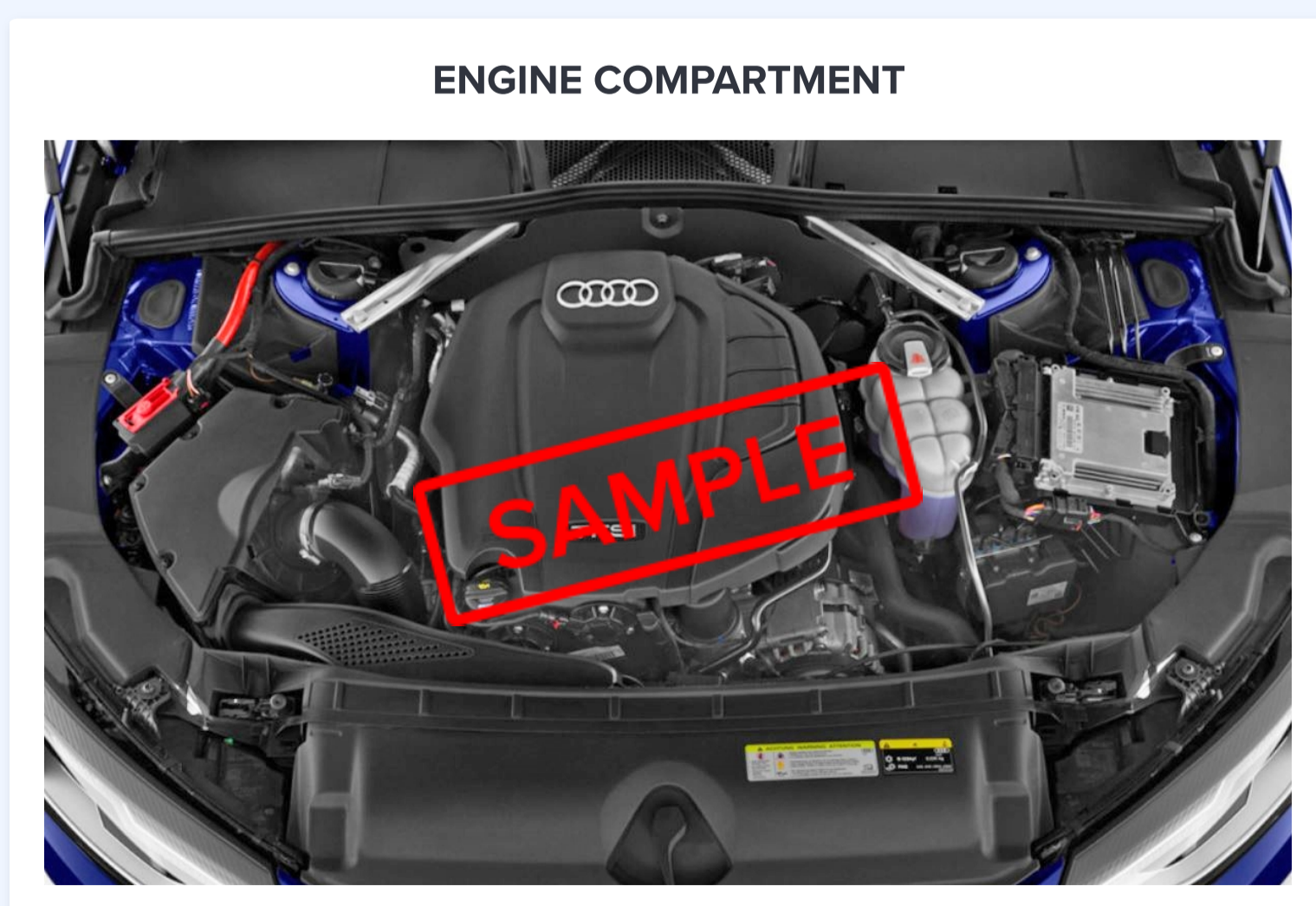

Miscellaneous

Airbags are Available?	✓	Cruise Control is Available?	✓
VIN/Chassis Number matching with document?	✗	Medical Kit available?	✗
Vehicle jack and wrench available?	✓	MIL/Engine Light is OFF?	✓

Images



Documents

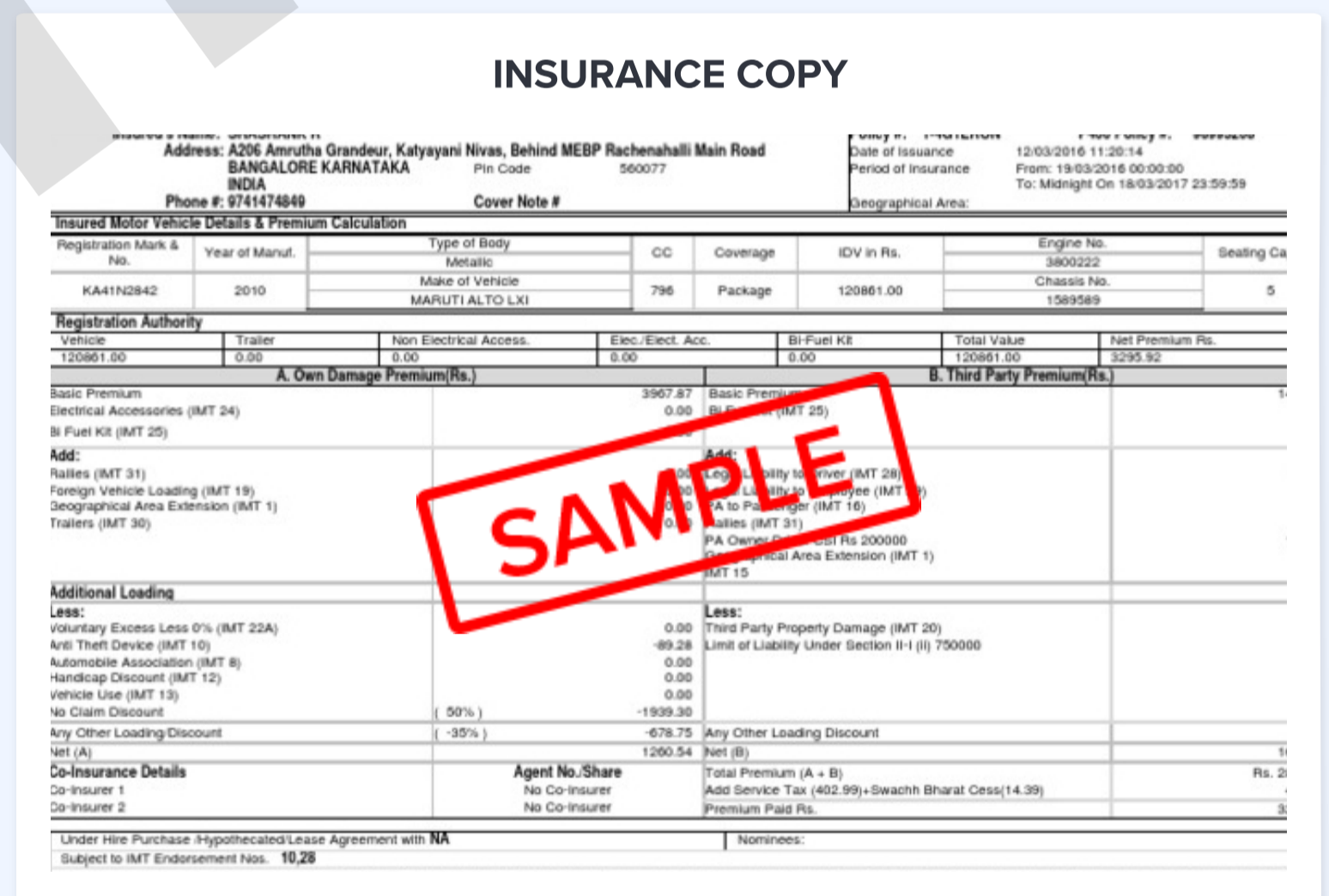
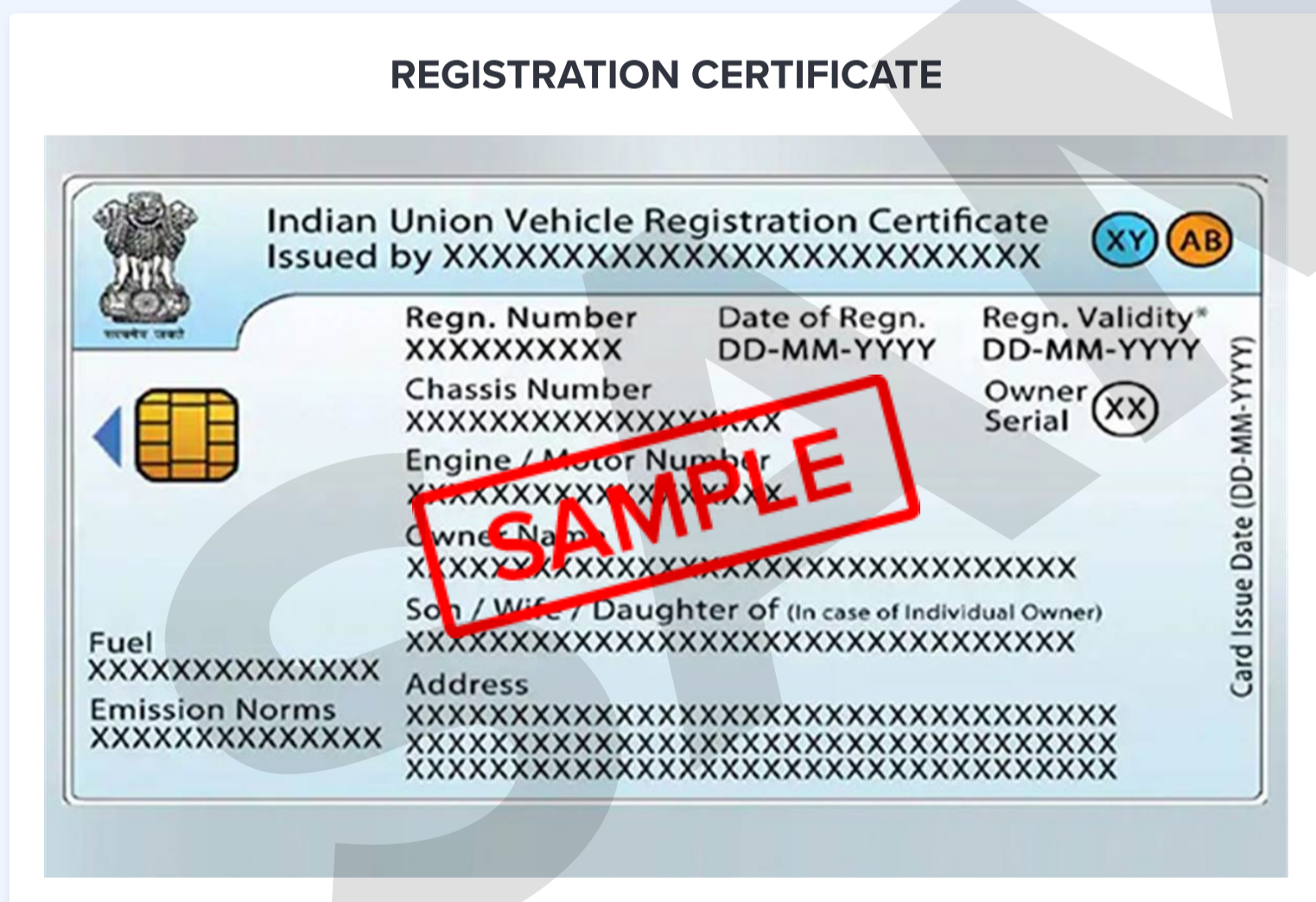

NEED ATTENTION

Interior

CENTRAL LOCK

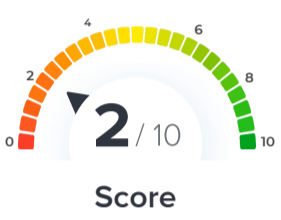

Remarks: Central Lock Not Working
Repair Estimate: ₹ 600

POWER WINDOW

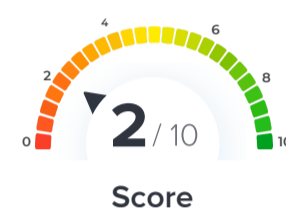

Remarks: Power Window Not Working
Repair Estimate: ₹ 600

Wheel

FRONT TYRES

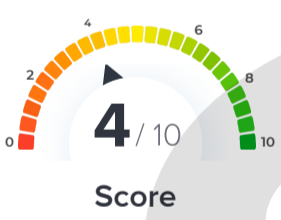

Remarks: Front tyres are not in a good condition
Repair Estimate: ₹ 600

SPARE TYRES

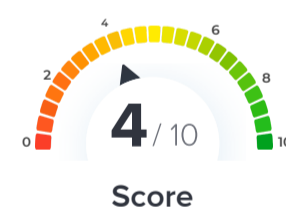

Remarks: Spare tyres are not in a good condition
Repair Estimate: ₹ 600

Exterior

FOG LAMPS

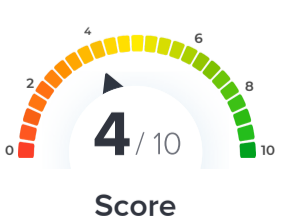

Remarks: Major cracks in Fog Lamps
Repair Estimate: ₹ 900

LEFT FRONT DOOR

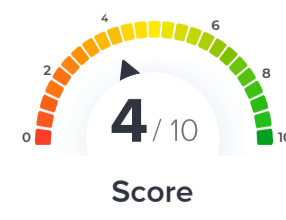

Remarks: Scratches/Dents in Front Door
Repair Estimate: ₹ 900



Other Images

GRILLE



FRONT BUMPER



REAR BUMPER

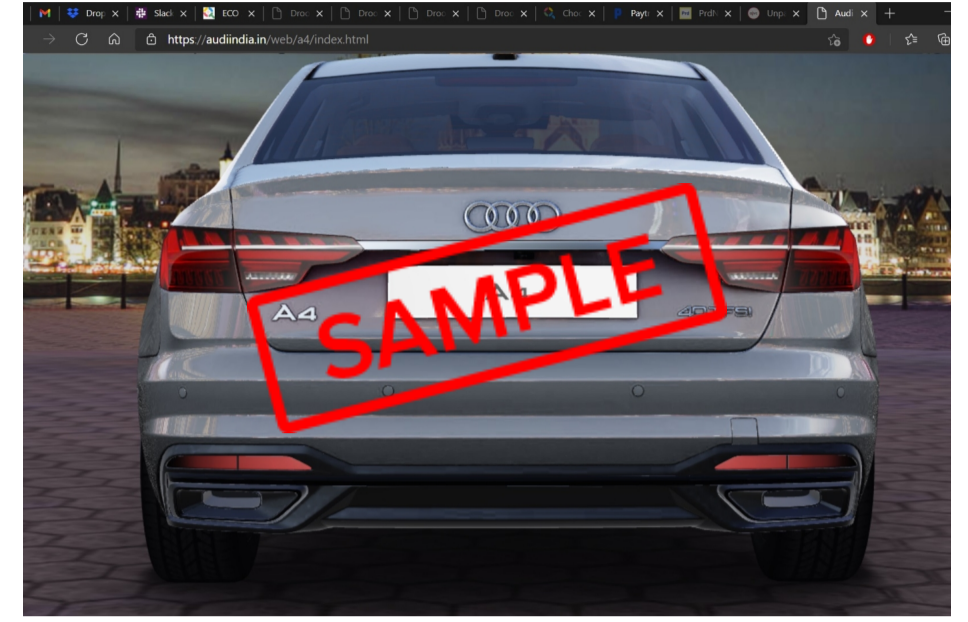

BONNET HOOD



FRONT WINDSHIELD



REAR WINDSHIELD



LEFT SIDE MIRROR



RIGHT SIDE MIRROR



LH FRONT DOOR



RIGHT FRONT DOOR



LEFT REAR DOOR



RIGHT REAR DOOR



LEFT FENDER



RIGHT FENDER



LEFT QUARTER PANEL



Other Images

RIGHT QUARTER PANEL



BOOT TRUNK LID



ROOF

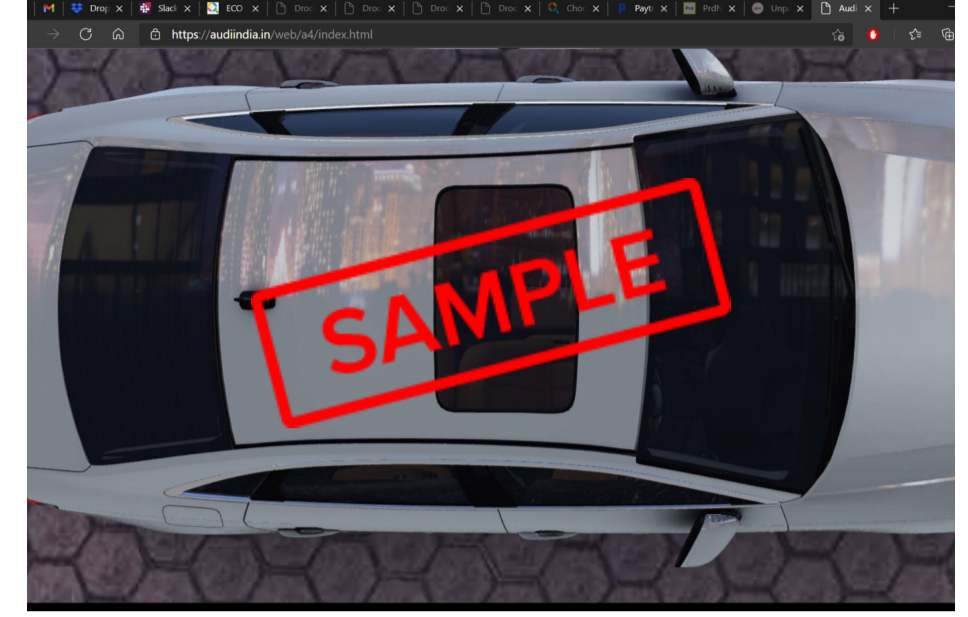

FRONT LICENSE PLATE



REAR LICENSE PLATE



HSRP COLOUR STICKER



FRONT WINDSHIELD WIPER



REAR WINDSHIELD WIPER



ODOMETER



POWER WINDOWS



REAR VIEW MIRROR



ENGINE COMPARTMENT



UNDERCARRIAGE



BATTERY



TRUNK LID

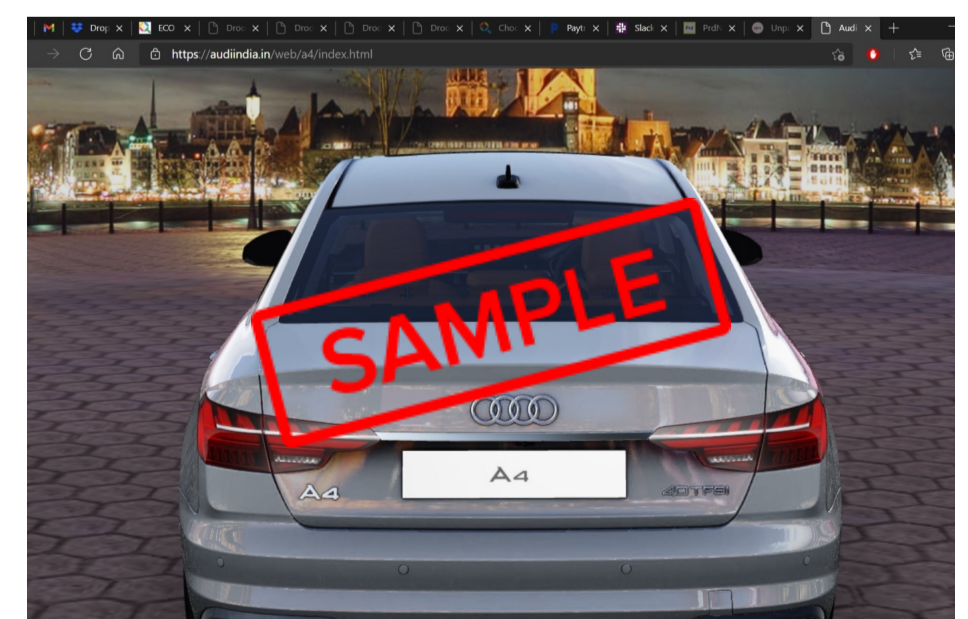

Other Images



Overall Comments

Car is in average condition

Disclaimer

This inspection report was generated by ECO, a service arm of Droom Technology limited. This report was generated based on the request raised by the party, whom the report is addressed to, for the stated purpose only. ECO will not be responsible for any loss incurred by the party relying on the inspection report.

All data presented in the report are based on the facts at the time of inspection and ECO cannot be held responsible for any discrepancy in the mentioned facts. ECO has not validated the authenticity of the odometer reading and is not responsible for any tampering performed by the current owner of the vehicle.

Ownership documents of the vehicle were verified by the technician performing the auto inspection. However, ECO is not responsible for validating the authenticity of the document.



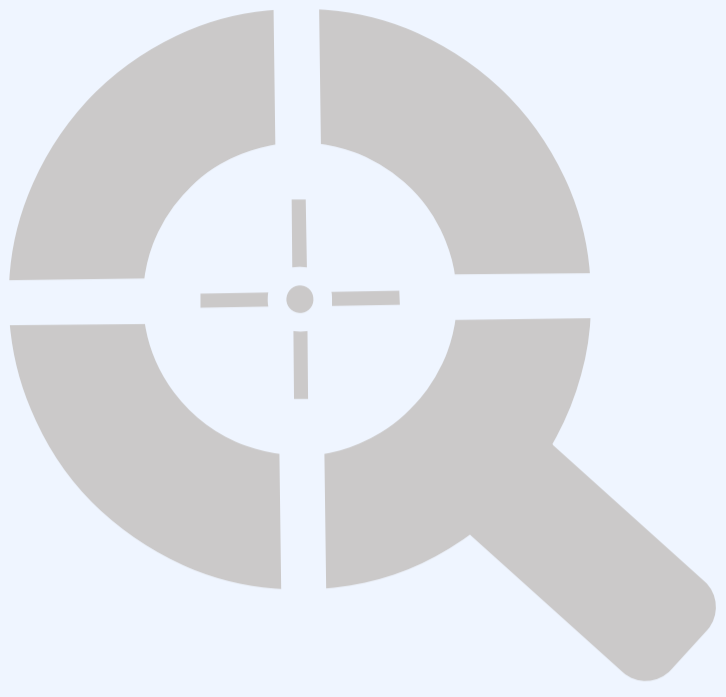

www.droom.in/eco